

# Bog Oak Ripples

BLANKET CHEST: Ref. 1501

The *Bog Oak Ripples* blanket chest is a limited-edition of 15, and has been awarded a prestigious Bespoke Guild Mark (No. 460).

This piece utilises our rippled forms, with the ripple starting from one corner and flowing across the surface to envelop the piece.

The design can be tailored to suit your specific requirements within the realms of the design i.e. a timber or suede lining.

Our rippled forms are produced in-house, and made using a unique technique that has been developed and perfected by Edward Johnson.

Originally inspired by the action of a stone dropping into water. Our rippled concept can be applied to nearly any piece of furniture with any desired function, in almost any wood.

Please get in touch to discuss the many options available.

Tel: +44 (0)1243 696606  
e-mail: [info@edwardjohnsonstudio.co.uk](mailto:info@edwardjohnsonstudio.co.uk)

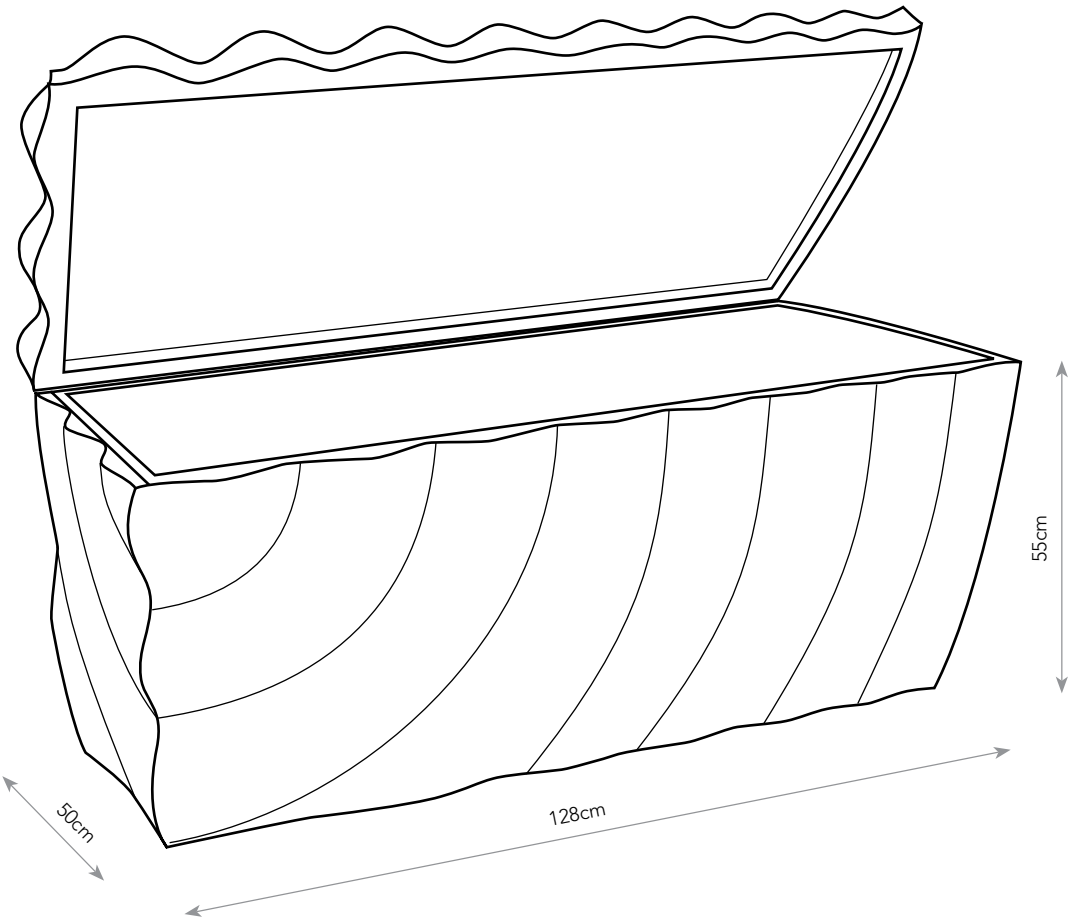

## Ripples timber samples

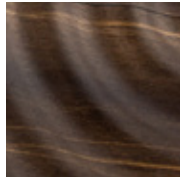

Bog Oak



Walnut

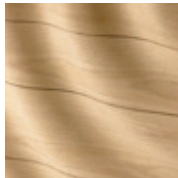

Ash



Limed Ash



Blue bird's-eye Maple

## Timber options (many options and combinations are available)



Sycamore



Ash



Burr Ash

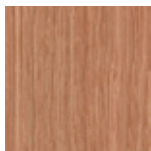

Oak

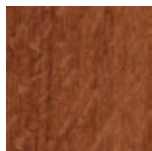

Brown Oak

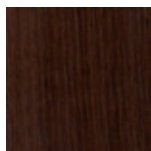

Fumed Oak



Maple

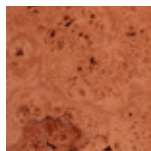

Burr Maple

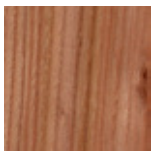

Elm

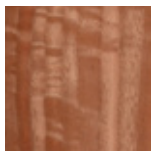

Eucalyptus

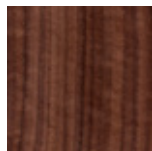

American Walnut

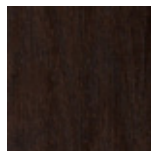

Bog Oak

Dimensions  
128cm (w) x 55cm (h) x 50cm (d)

